

FC-4D

DANTE® CEILING MOUNT LOUDSPEAKER



TECHNICAL DATA SHEET

PRODUCT SUMMARY

The Atlas+Fyne FC-4D is a wide bandwidth 4" ceiling mount loudspeaker designed for the ultimate in fidelity, coverage, and aesthetics.

For the first time, the combination of IsoFlare™ transducer technology, the flexibility of the Audinate Dante® digital audio transport platform, optimal power (PoE++), and loudspeaker management is incorporated in a premium package.

A single CAT cable connects the FC-4D to the flexibility and convenience of networked audio, allowing designers, integrators, and installers access to advanced features like system configuration, supervision, and calibration tools.

Powered by PoE+ or PoE++ and compatible with both Dante and AES67 IP audio streams, the IsoFlare™ FC-D range is flexible, scalable and powerful. A second amplifier output is incorporated to allow local connection to a passive Atlas+Fyne loudspeaker.

IsoFlare™ is the new benchmark in point source technology for prestigious commercial environments. Decades of experience from acoustic and mechanical engineers specializing in this technology have honed existing skills complemented with the very latest in design & engineering techniques to bring IsoFlare™ to the premium commercial space in an integrated package.

Unlike discreet and 'coax' offerings, the IsoFlare™ driver exhibits excellent harmonic alignment between HF and LF sources, delivering accurate and natural reproduction with superb tonal balance. Propagating a spherical wavefront, homogeneously aligned on all axes, the IsoFlare™ point source driver yields an even response throughout the listening area, while a constant time delay over the entire frequency spectrum provides exceptional off-axis performance.

The FC-4D is designed for applications requiring a combination of premium sonic quality for music and speech reinforcement with exceptional reliability, in an architect/designer/installer friendly solution.

KEY FEATURES

- Patented toolless high travel secure-clamp mechanism for fast and trouble-free installation
- Bezel-less grille – magnetically secured, removable logo. Allows for a single-step painting process if necessary. No requirement for adapters to accommodate optional square grilles.
- Consistent voicing and measured performance across all IsoFlare™ Series products whether ceiling-, surface- or pendant-mount
- Integrated DSP and Amplifiers, Power-over-Ethernet (PoE+ or PoE++)
- AtlasIED Discover software-based configuration, control, and telemetry
- Multiple configuration options
- Visual and audible locator
- Dante and AES67 compatible
- Dante Domain Manager compatible
- Full control and monitoring of individual and multi-zones
- Secondary output for powering a passive Atlas+Fyne loudspeaker
- Ferrofluid-cooled titanium HF driver with neodymium magnet system
- Weather treated multi-fiber paper cone – stiffness combined with a controlled top end roll-off for an accurate midrange

APPLICATIONS

- Boardrooms & Corporate Offices
- Airports, Convention Centers, Hotels
- Casinos
- Houses of Worship
- Retail Outlets, Shopping Malls
- Museums
- Lounges/Bars
- Sports Facilities
- Health Clubs
- Performing Arts Centers
- Education Facilities
- Cruise Ships
- Courtrooms
- Multi-zone Foreground Music & Paging Systems

FC-4D

DANTE® POE CEILING MOUNT LOUDSPEAKER



TECHNICAL DATA SHEET

AUDIO SPECIFICATIONS/PERFORMANCE

SYSTEM	FC-4D
Type	Active two-way, full-range ceiling mount loudspeaker (blind mount)
Frequency Range (-10 dB) ¹	62 Hz–30 kHz
Frequency Response (+/-3 dB) ¹	80 Hz–22 kHz
Nominal Coverage Angle	100°
Directivity Index (dB) ⁴	4.7

AMPLIFICATION²

Type	Two-Channel, Class D
Power Source - Supported PoE Standards	PoE++ Type 4, PoE++ Type 3, PoE+ Type 2
Secondary Amplifier Output Power	
PoE++ Type 4	46 W Burst (20 ms) ² 36 W RMS ²
PoE++ Type 3	37 W Burst (20 ms) ² 30 W RMS ²
PoE+ Type 2)	16 W Burst (20 ms) ² 10 W RMS ²
Secondary Amplifier Output Supported Impedance	8 Ω
Current Consumption	
Idle	28 mA / 3.6 Btu
PoE+ Type 2, 30 W	248 mA / 32.1 Btu
PoE++ Type 3, 60 W	505 mA / 65.5 Btu
PoE++ Type 4, 90 W	757 mA / 98.2 Btu
Rated Maximum SPL@1m ⁽³⁾	
PoE++ (802.3bt Type 4)	106 dB ⁽⁵⁾ (Average) / 112 dB (Peak)
PoE++ (802.3bt Type 3)	106 dB (Average) / 112 dB (Peak)
PoE+ (802.3at Type 2)	103 dB (Average) / 109 dB (Peak)

TRANSDUCERS

IsoFlare™ Point Source Driver	
Low Frequency	4" (100 mm) Bass/Mid, multi-fiber treated paper
High Frequency	0.75" (19 mm) titanium dome with neodymium magnet system, ferrofluid cooled

SOFTWARE

AtlasIED Discover Software	Network Status, Configuration, Telemetry, DSP Control, Locate
----------------------------	---

NETWORK

IP Mode	Static or DHCP (default)
Ethernet Connection	IEEE 802.3/100Base-TX
Audio-over-IP streaming formats	Dante, AES67
PoE+/PoE++	Type 2, Type 3, Type 4 Compliant
CAT Cable Specification	5, 5e, 6
Maximum CAT Cable Length	100 m (333 ft)
Minimum delay from input to acoustic output	2.18 ms

FC-4D

DANTE® POE CEILING MOUNT LOUDSPEAKER



TECHNICAL DATA SHEET

AUDIO SPECIFICATIONS/PERFORMANCE (CONTINUED)

PHYSICAL	
Back Can	Powder-coated steel (Black)
Baffle	High Impact ABS UL-V0 (black)
Grille	Steel, weather resistant coating (white)
Safety Features	Safety ring for load-bearing safety bond
Clamping Design	SafetyFirst™ with locking dog legs Min/Max Clamping Range: 0.33"–2.00" (8.38 mm–50.8 mm)
Cable Entry Options	Cable clamp & squeeze connector for conduit up to 22 mm (0.87")
Connectors	(1) RJ45 (input), (1) Euroblock with screw terminal (second amplifier output)
Safety Agency Ratings	Safety: UL2043, Conforms to UL62368-1, Certified to CSA STD 22.2 No. 62368-1 EMC:-FCC Part 15, Subpart B, EN 55032, EN 55035, EN IEC 6100, EN 6100 Suitable for use in Air Handling Spaces per NFPA 70 and NFPA 90.
Ingress Protection	IP44
Operating Temperature	10° F to 120° F (–12°C to 49° C)
Baffle Diameter	ø 8.42" (214.0 mm)
Back Can Diameter	ø 7.32" (186.0 mm)
Cutout Diameter	ø 7.56" (192.0 mm)
Mounting Depth	8.96" (227.5 mm)
Overall Depth	9.08" (230.6 mm)
Round Grille Diameter	ø 8.58" (218.0 mm)
Square Grille Length	8.58" (218.0 mm)
Included Accessories	C-ring, tile-bridge kit, cut-out template, round white grille
Optional Accessories	Round black grille, square white grille, square black grille
Packed Quantity	2
Shipping Dimensions (H × W × D)	14.6" × 33.7" × 18.1" (370 mm × 855 mm × 460 mm),
Net Weight (per unit)	7.24 lbs (3.29 kg)
Shipping Weight	27.16 lbs (12.35 kg)
WARRANTY COVERAGE	
Warranty Period	5 Years

Notes:

1 - Average over stated bandwidth, full space, IEC baffle

2 - Power Level - Test is defined as follows: 1 kHz sine wave signal burst of 20 cycles (20 ms) at 1% THD+N, followed by 480 cycles of a 1 kHz sine wave at 10% of the maximum power.

3 - Calculated from rated noise power and sensitivity

4- 1 kHz–10 kHz average

5- DSP limited

A full range of measurements, performance data, Ease™ and CLF data can be downloaded from www.atlasied.com.

FC-4D

DANTE® POE CEILING MOUNT LOUDSPEAKER



TECHNICAL DATA SHEET

PERFORMANCE MEASUREMENTS

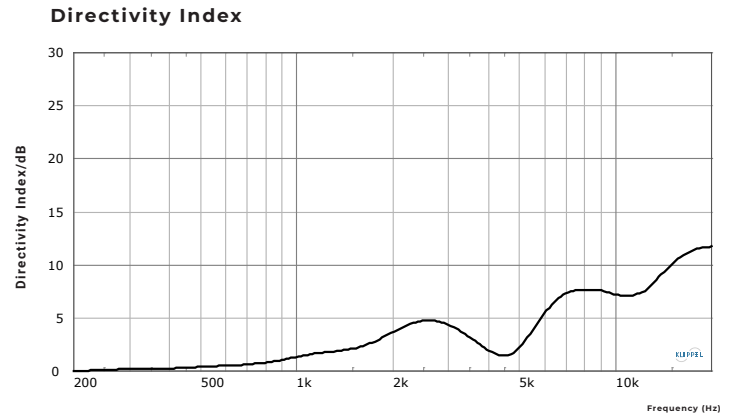
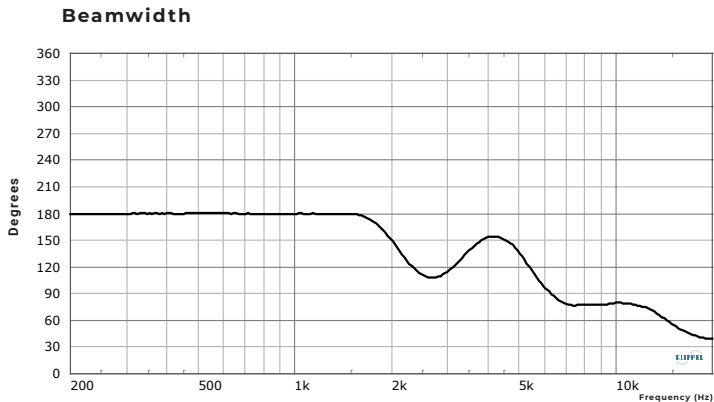
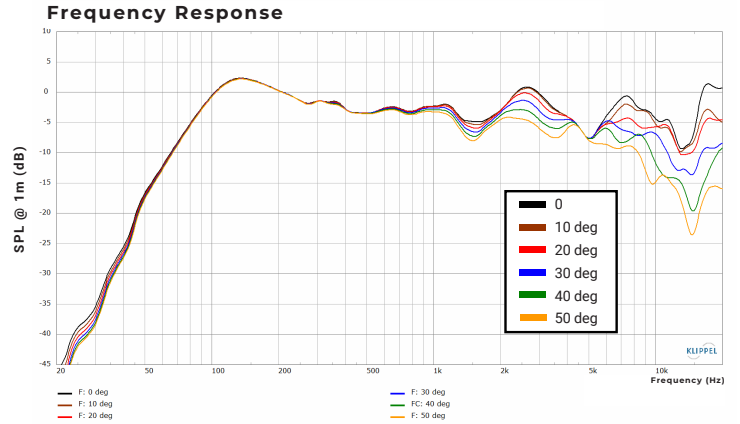
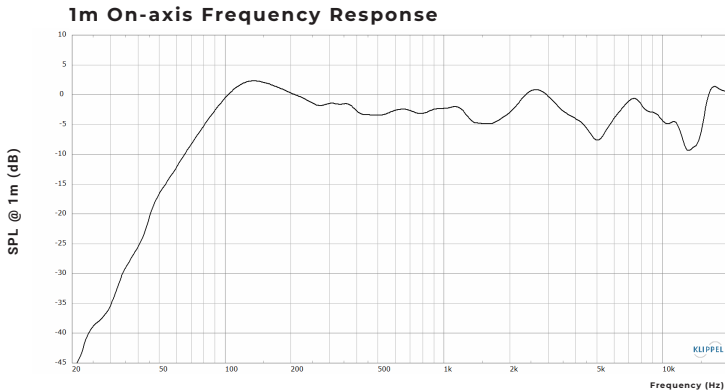

Polar Plots (Octave)

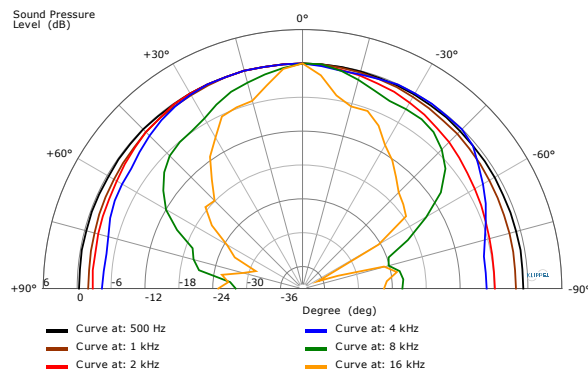

FC-4D

DANTE® POE CEILING MOUNT LOUDSPEAKER



TECHNICAL DATA SHEET

DIMENSIONAL DRAWINGS

PRODUCT DIMENSIONS

Baffle Diameter	ø 8.42" (214.0 mm)
Back Can Diameter	ø 7.32" (186.0 mm)
Cutout Diameter	ø 7.56" (192.0 mm)
Mounting Depth	8.96" (227.5 mm)
Overall Depth	9.08" (230.6 mm)
Round Grille Diameter	ø 8.58" (218.0 mm)
Square Grille Length	8.58" (218.0 mm)

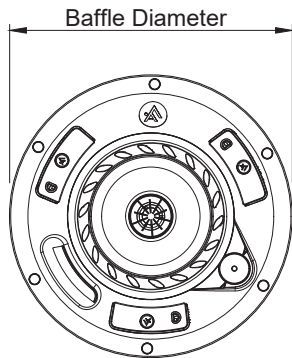

Front View

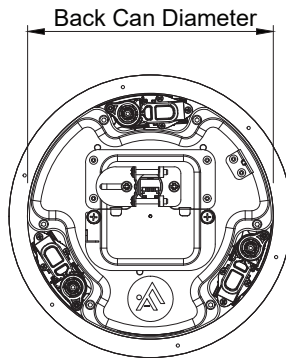

Rear View

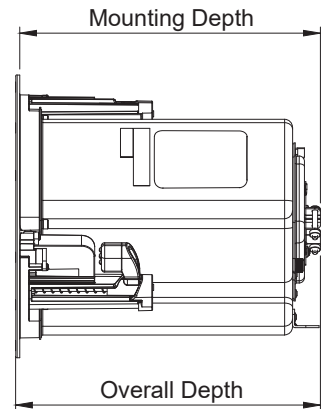

Side View

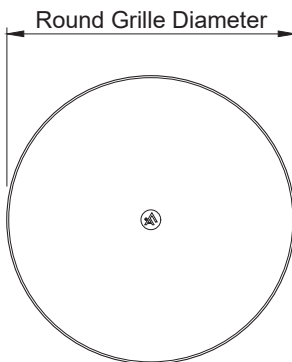

Round Grille

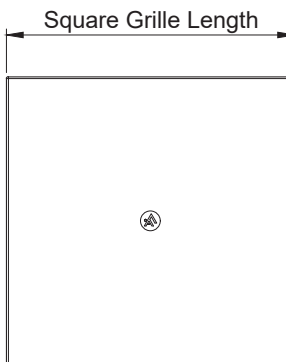

Square Grille

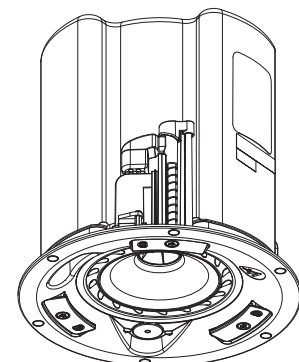

Isometric View

FC-4D

DANTE® POE CEILING MOUNT LOUDSPEAKER



TECHNICAL DATA SHEET

ARCHITECT & ENGINEER SPECIFICATIONS

The loudspeaker shall be of a two-way flush-mount design. A 4" (100 mm) multi-fiber treated paper woofer with butyl rubber surround and 0.75" (19 mm) titanium dome with ferrofluid-cooled neodymium magnet system shall be housed in a proprietary, injection-molded ABS ULV-0, fade resistant vented baffle. The back can shall be of powder-coated steel construction. The enclosure shall exceed IEC 60529 IP44 ratings for dust and splash resistance. Incorporated is a sealed input panel cover, and powder-coated aluminum grille.

A recessed termination box shall be integrated with the back can, consisting of an RJ45 port and removable Euroblock screw terminals for direct connection to a second, passive loudspeaker. Strain relief shall be provided by a clamping mechanism for use with plenum-rated cable or conduit. The loudspeaker shall incorporate a toolless, high-travel dog-leg mounting mechanism. It shall utilize a one-piece, bezel-less grille and an optional square grille if required.

The loudspeaker shall comply with the following standards: UL62368-1; CSA STD 22.2 No. 62368-1; EMC: FCC Part 15, Subpart B; EN 55032; EN 55035; EN IEC 6100; EN 6100. The loudspeaker shall be suitable for use in air handling spaces per NFPA 70 and NFPA 90.

The loudspeaker shall meet the following performance specifications: On-axis system frequency range shall be 62 Hz to 30 kHz (-10 dB). The maximum continuous output shall be 106 dB SPL and the maximum peak output shall be 112 dB SPL (PoE++ Type 4). The nominal coverage pattern shall be 100 degrees conical.

The loudspeaker grille diameter shall be 8.58" (218.0 mm) and the loudspeaker shall be 9.08" (230.6 mm) deep (to top of safety ring). The unit net weight shall be 7.24 lbs (3.29 kg).

Two support rails and one C-ring for mounting shall be included.

The warranty shall be 5 years.

The loudspeaker shall be the Atlas+Fyne FC-4D ceiling mounted loudspeaker.