

PROXP-20-FS
POLARIS® RZR® PRO XP FRONT SPEAKER PODS
OWNER'S MANUAL



THANK YOU

Thank you for making the AWESOME decision to purchase our MTX Audio 6.5" weatherproof speakers for your Polaris® RZR® Pro XP. With a few simple tools from your trusty toolbox you'll have these installed in no time. The rotationally molded enclosures are built as a single piece, designed to take years of abuse without failure and they install quickly with only minor disassembly of the vehicle. And of course, who can forget the integrated RGB lighting in the speakers, because, who doesn't like things that light up, right? So, congratulations on your purchase, thanks for your support and most importantly, enjoy the ultimate audio experience with MTX!

WE'RE HERE TO HELP

We're here to help with any installation or technical support. Visit mtx.com to chat, call 1-800-225-5689 to speak with an MTX Technical Support representative, or visit youtube.com/user/MTXAudioUSA to view product videos.

DON'T FORGET TO REGISTER YOUR PRODUCT

Don't forget to register your new MTX Audio product. Visit mtx.com/productregistration or scan the QR code to the right.

Model # _____

Serial # _____

Dealer's Name _____

Date of Purchase _____



IMPORTANT NOTICE

Whenever working on the vehicle, it is recommended to disconnect the battery prior to starting work. Failure to do so may lead to a risk of electric shock or equipment damage.

When connecting power and ground wires ensure that the red power wire is fused at the point where it is connected to the vehicle's battery. Failure to do so can result in damage to the vehicle if a short circuit develops between the vehicle connection point and the product.



FEATURES

Tweeter:

- Teteron Dome Tweeter for High Output and Accurate Audio Reproduction
- Adjustable Tweeter Attenuation for Fine Tuning of Output
- Tweeter Mounts in OEM Factory Housing

Midrange:

- Fully Assembled and Prewired Enclosure
- Installer Friendly Enclosure Design for Easy Installation
- Integrated RGB Lighting
- Mounts Behind Factory Grille Maintaining OEM Cosmetics
- Utilizes Factory Mounting Assembly
- Compatible with OEM or MTX Subwoofer Installed

SPECIFICATIONS

- RMS Power Handling: 75-Watts
- Peak Power Handling: 150-Watts
- Sensitivity (2.83V/1m): 92dB
- Sensitivity (1W/1m): 87.6dB
- Frequency Response: 70Hz - 20kHz
- Impedance: 3.4Ω

FIT GUIDE

| | |
|----------------------------------|-------------|
| Pro XP / XP4 Sport | 2021 - 2022 |
| Pro XP / XP4 Premium | 2020 - 2022 |
| Pro XP / XP4 Ultimate | 2020 - 2022 |
| Pro XP / XP4 Sport RFLE | 2021 |
| Pro XP / XP4 Ultimate RFLE | 2021 |

IN THE BOX

- PROXP-20-FS Speaker Pods and Tweeters
- Mounting Hardware
 - (2) Mounting Brackets, (1) per Enclosure
 - (2) T30 Torx Course Thread - 20mm Long
 - (4) T20 Torx Course Thread - 15mm Long
 - (8) T20 Torx Course Thread - 29.5mm Long
 - (8) Zip Ties

DISASSEMBLY

Step 1 - Remove the speaker grille by removing two (2) T-40 TORX bolts.

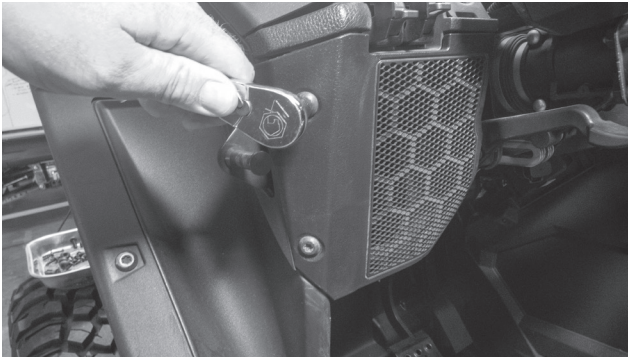

Note: For vehicles that have the OE speaker pods installed follow these additional steps for removal.

Step 2 - Remove four (4) T-25 screws found around the front of the speaker.

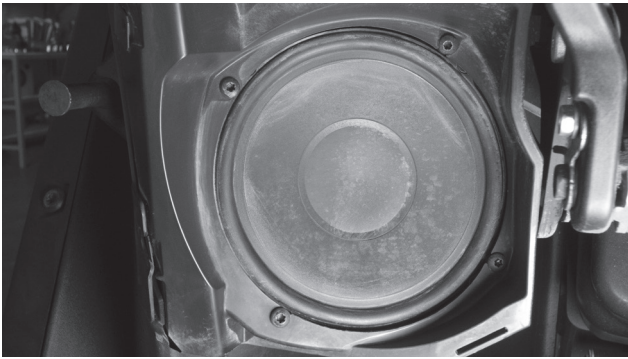

Step 3 - Remove two (2) T-27 screws found at the back of the speaker pod on the firewall.

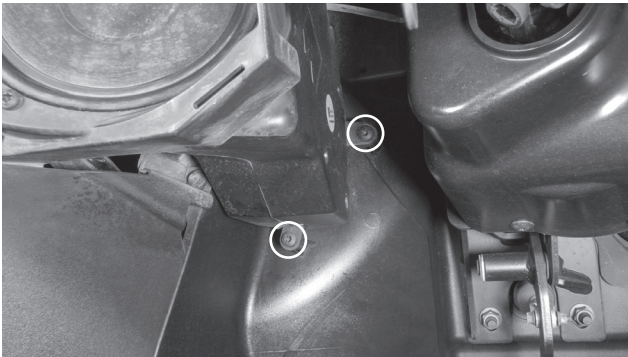

Step 4 - Remove one (1) T-40 Bolt from the inside fender well.

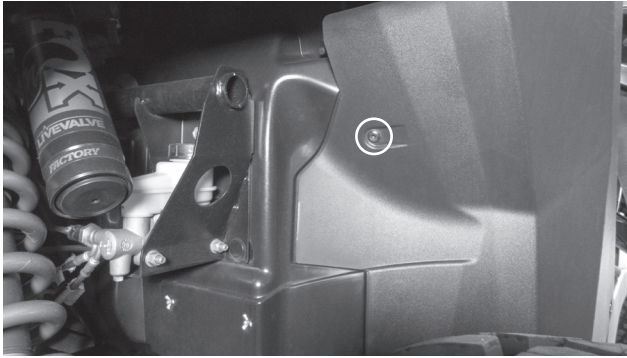

Step 5 - Disconnect the speaker pod plug and remove the pod from the vehicle.



Step 6 - Repeat this process on the other side.

Step 7 - With the pods removed, reinstall the T-40 TORX bolt into the fender well location.

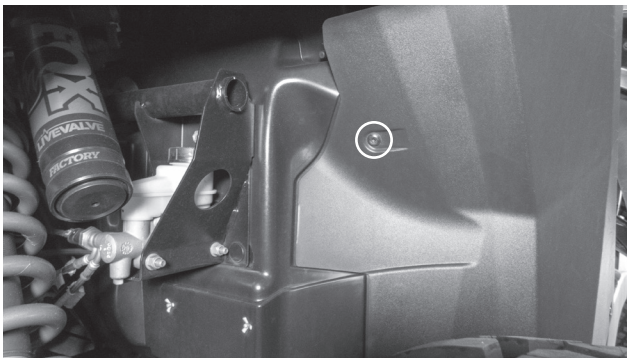

Step 8 - Repeat process for other side of the vehicle.

Step 9 - Disengage the speaker pod from the top of the dash/ fender panel and slide up the cage tube.

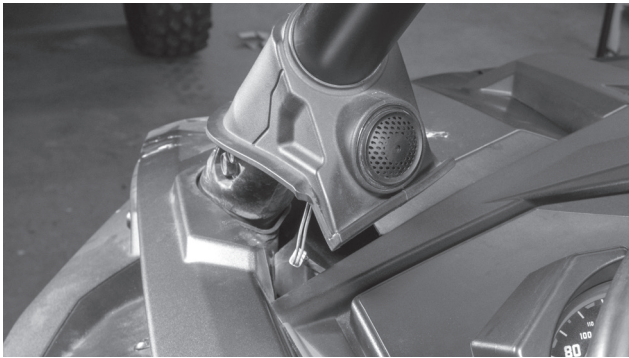

Step 10 - Press the dummy plug or OE tweeter if installed from the front and remove from the enclosure from the rear.



Step 11 - If OE tweeter is installed, disconnect the harness connector.

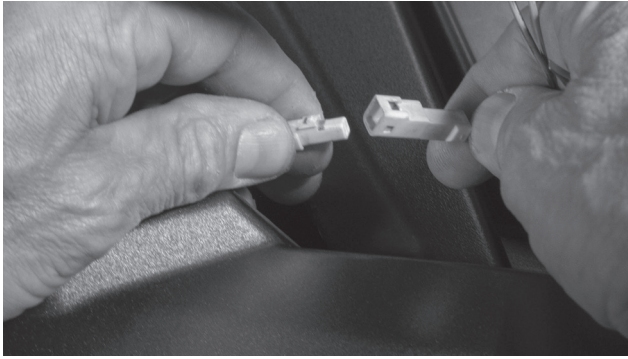

Step 12 - Repeat process for other side of vehicle.

INSTALLATION

Step 13 - Locate and install the rear support brackets as shown using the supplied four (4) 15mm T-20 TORX screws.



Step 14 - Placing the Speaker enclosure against the dash housing from the rear and holding it in place, loosely install four (4) 30mm T-20 TORX screws from the front into the enclosure housing in the predrilled holes.

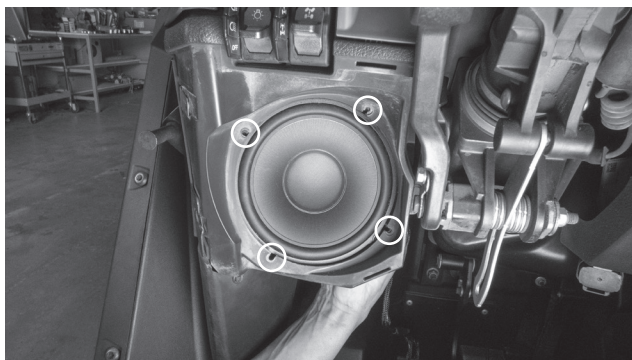
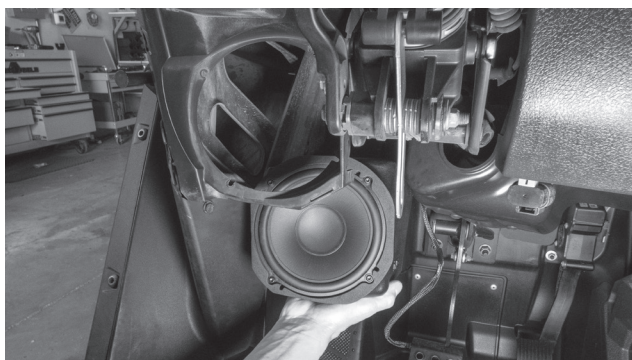

Step 15 - Align the rear support bracket with the factory screw location in the firewall and install one (1) T-27 TORX screw and tighten.

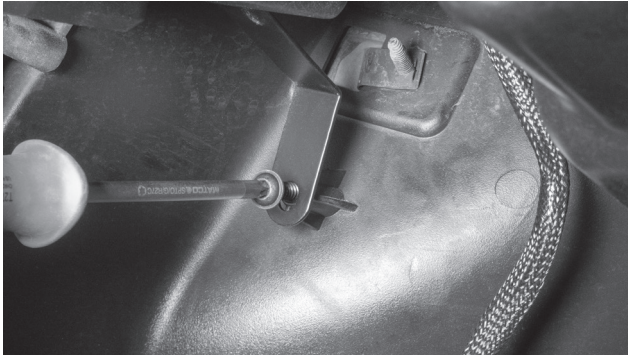

Step 16 - Tighten the four (4) screws on the front of the enclosure.

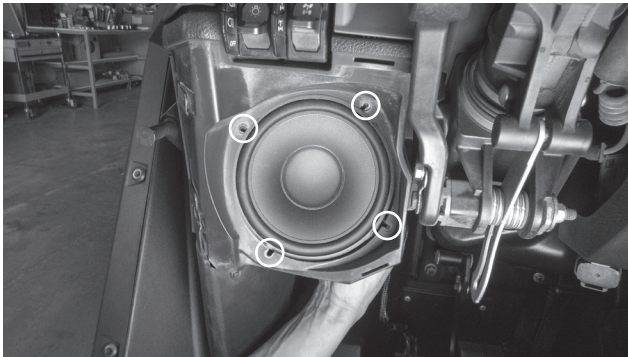

Step 17 - Feed the tweeter harness connector up through the top of the dash.



Step 18 - Repeat process for the other side of the vehicle.

Step 19 - Prior to installation, choose your tweeter attenuation preference, 0dB or -6dB, by moving the jumper found on the back of the tweeter housing.

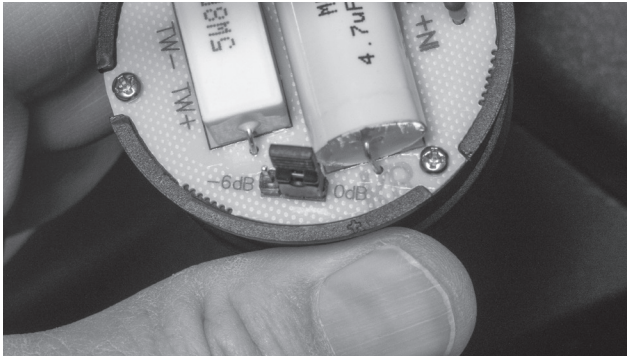

Step 20 - Locate and align the key on the body of the tweeter pod to the slot molded into the tweeter opening on the factory housing.

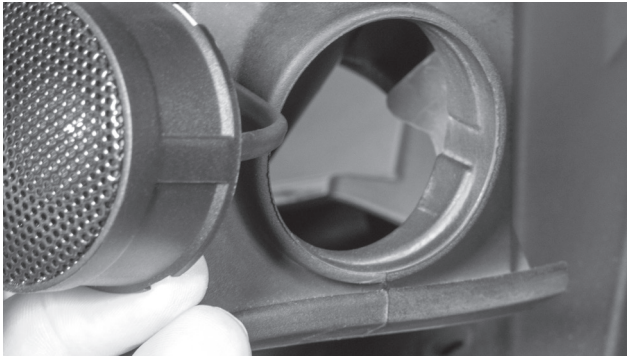

Step 21 - Press the tweeter into the opening from behind until the grille is seated flush with the front of the enclosure.



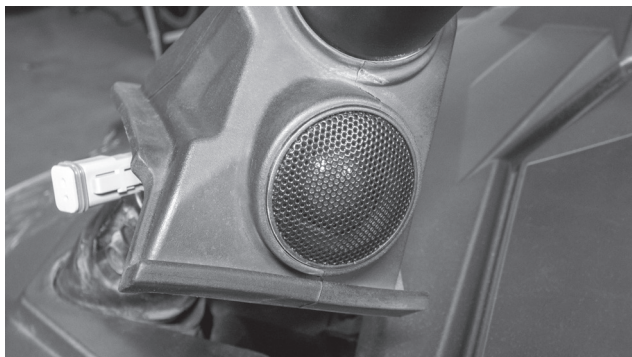

Step 22 - Connect the harness connector from the lower speaker enclosure to the tweeter harness.



Step 23 - Repeat the process for the other side of the vehicle.

Note: If installing as part of an MTX Thunder kit, route the enclosure harness to the center of the dash and connect to the labeled connector.

If NOT installing as part of an MTX Thunder kit, the speaker plug will need to be removed and hardwired. Refer to the below diagram for wiring connections.

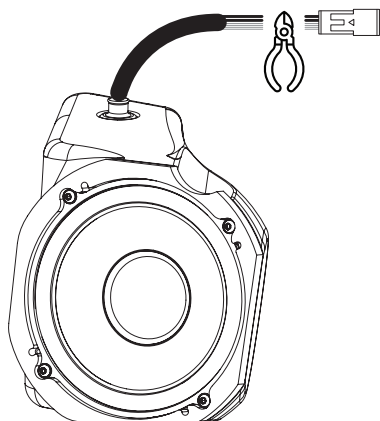

| |
|--------------|
| Speaker Wire |
| Gray (+) |
| Blue (-) |
| LED Wire |
| Red |
| Green |
| Blue |
| Black |

Once connected, test for function.

Step 24 - Slide the tweeter housing back down and reseal the housing to the fender and dash panel

Step 25 - Install the supplied MTX badge to the factory grilles with the supplied hardware.



Step 26 - Reinstall the factory grilles using factory hardware removed earlier.

Step 27 - Reassemble and go ride.

WARRANTY PERIOD

At MTX Audio we engineer products that will stand up to the test of time. We also realize that from time to time a problem may occur. That's why our products carry a 2-year limited warranty that begins at the time of sale to the end user.

Of course, we're here to help. If you experience an issue with any of our products within the warranty period, please contact our customer service technical line at 1-800-CALL-MTX to help troubleshoot your issue. If, after speaking with our technical experts it is determined that a problem lies with the product, the technician will provide you with a Return Authorization number and all relevant details you'll need to get the product taken care of.

MITEK WARRANTY

MiTek Mobile products (including, but not limited to: MTX, Coustic, Streetwires, Xtant, BassSlammer, and Thunder Marine) purchased in the USA from an AUTHORIZED MITEK DEALER are guaranteed against defects in material and workmanship for the period of time specified. The warranty period begins the day the product is purchased by the end user, and this warranty is limited to the original retail purchaser of product. Products found to be defective during the warranty period will be repaired or replaced with equivalent product by MiTek at no charge. This warranty is void if it is determined that unauthorized parties have attempted repairs or alterations of any nature, and the warranty does not extend to cosmetics or finish. MiTek disclaims any liability for other incurred or consequential damages resulting from product defects. MiTek's total liability will not exceed the purchase price of the product.



Let's Get Social
mtx.com



Like, Follow, & Subscribe

© 2021 MiTek Corporation. All rights reserved. MTX is a trademark of MiTek Corporation. All other trademarks are property of their respective owners. Designed and Engineered in the U.S.A.

Due to continual product development, all specifications are subject to change without notice.

MTX Audio, 4545 East Baseline Rd. Phoenix, AZ 85042 U.S.A. 1-800-225-5689

MTX006856 RevA 12/21 • AW0016029 • 1-14927